

Tentative Subdivision Map No. 4 of The Villages at Sierra Vista:
VILLAGES CO-01, CO-02, CO-03, CO-20, CO-21 AND CO-22

A PORTION OF SECTIONS 35 AND 36, T. 11 N., R. 5 E., M.D.M.
 City of Roseville, State of California
 Scale 1" = 50' June 2021

Sheet 6 of 14

Project Address - 3871 Santucci Boulevard

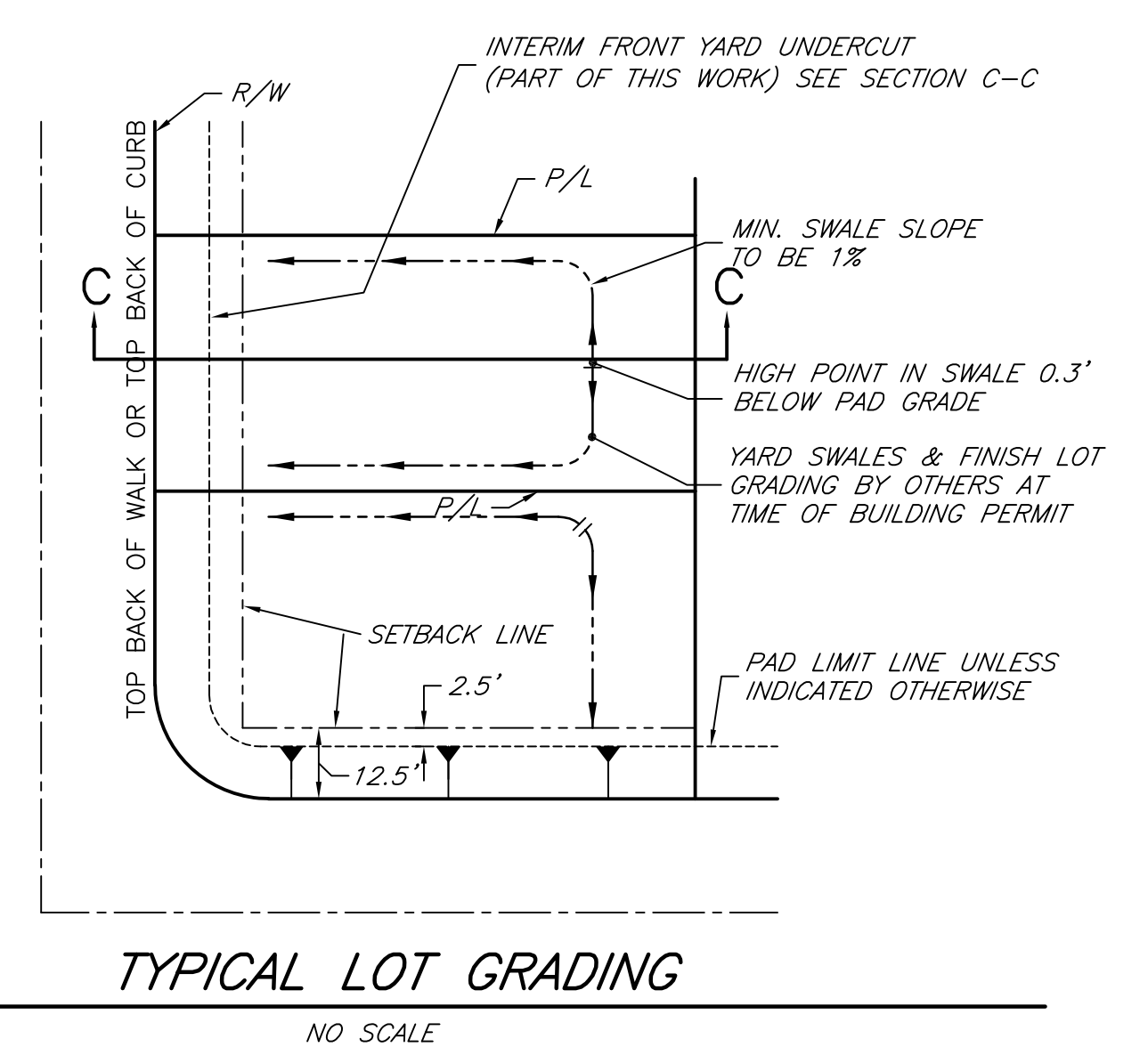
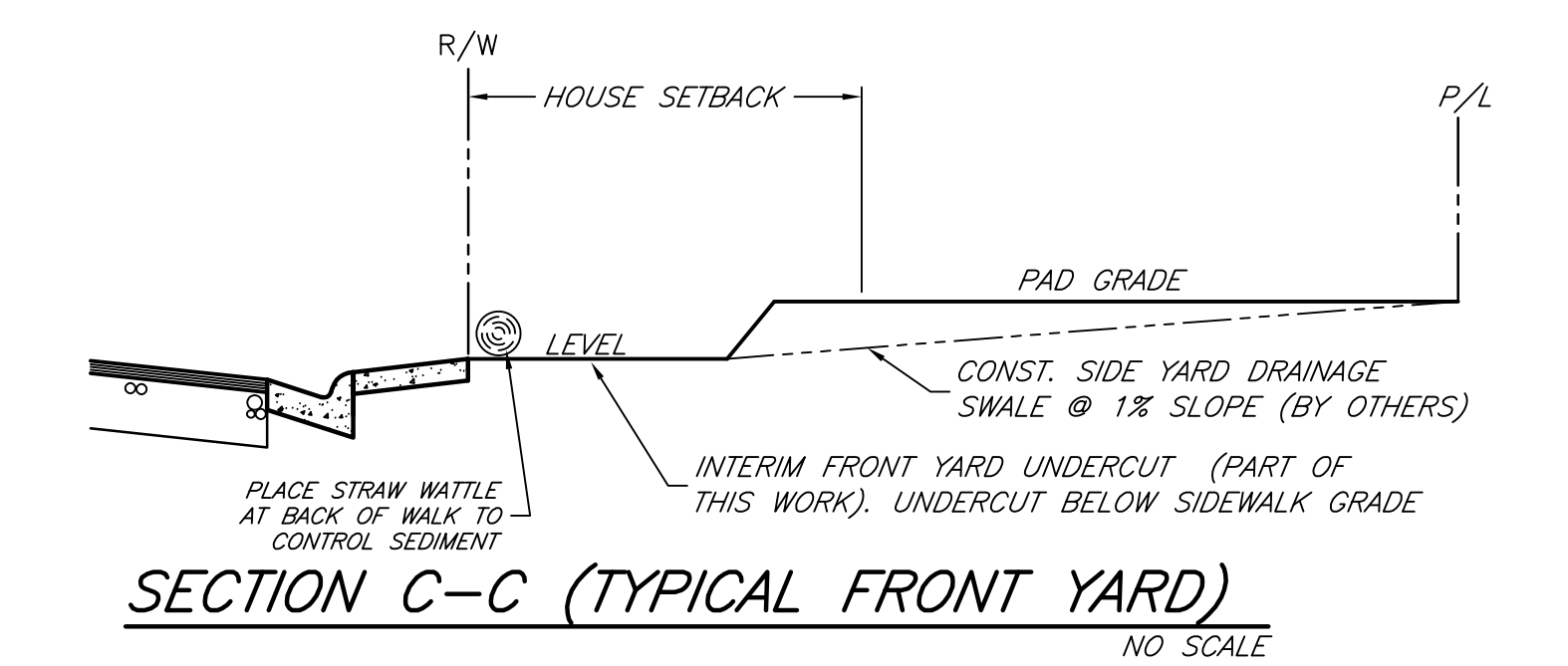
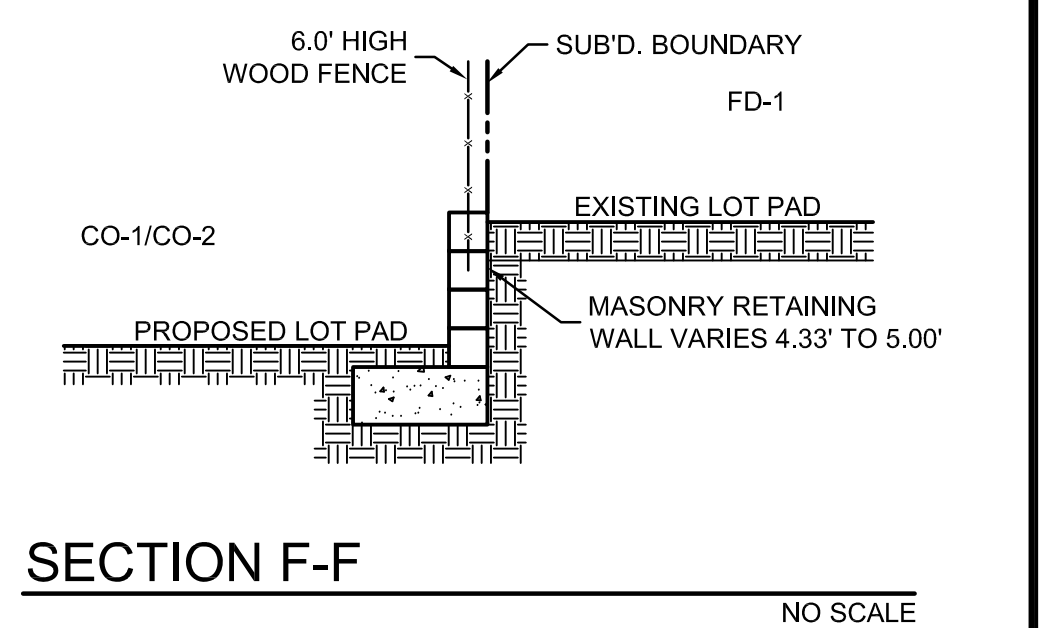
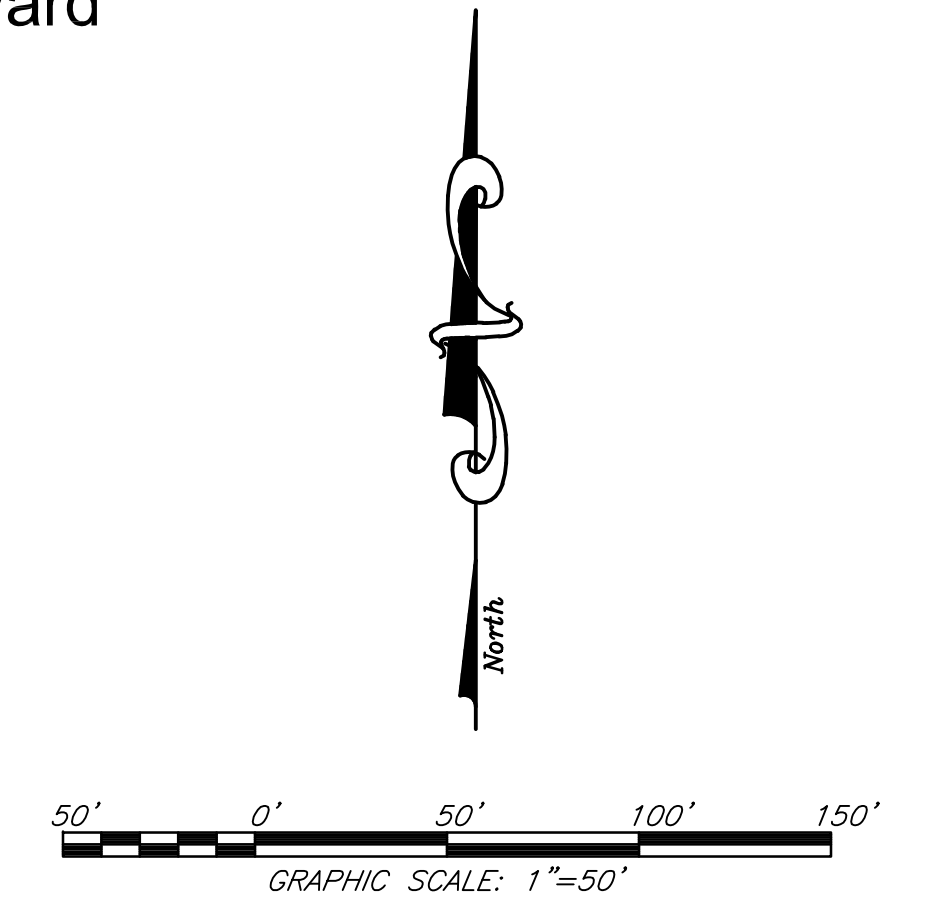
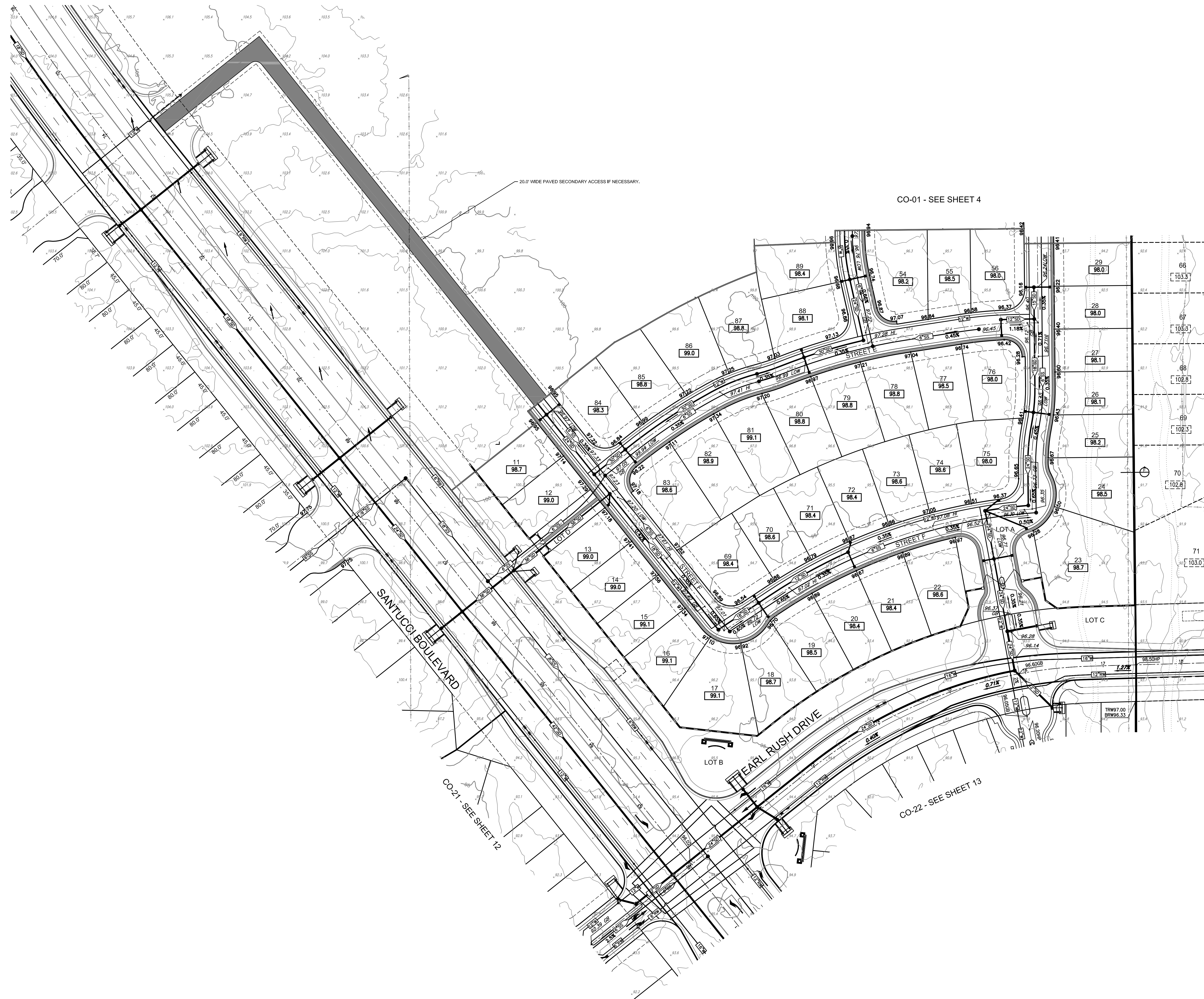

Tentative Subdivision Map No. 4 of The Villages at Sierra Vista:
VILLAGES CO-01, CO-02, CO-03, CO-20, CO-21 AND CO-22

A PORTION OF SECTIONS 35 AND 36, T. 11 N., R. 5 E., M.D.M.
 City of Roseville,
 Scale 1" = 50'
 State of California
 June 2021

Sheet 8 of 14

Project Address - 3871 Santucci Boulevard

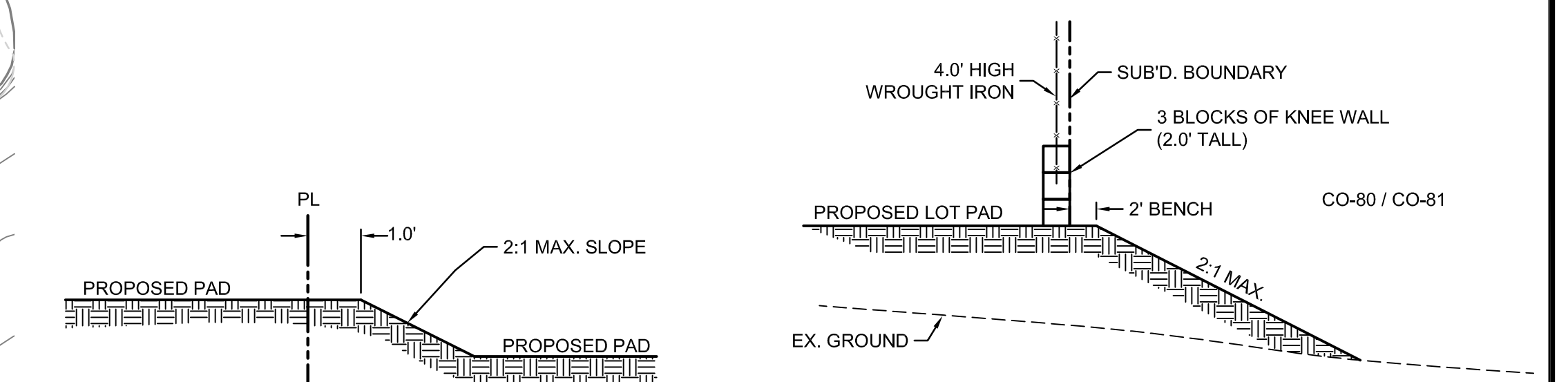
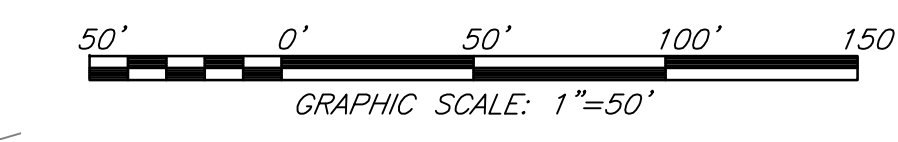

SECTION A-A
 TYPICAL SECTION WHERE THERE IS A STEP BETWEEN PADS
 NO SCALE

SECTION C-C
 NO SCALE

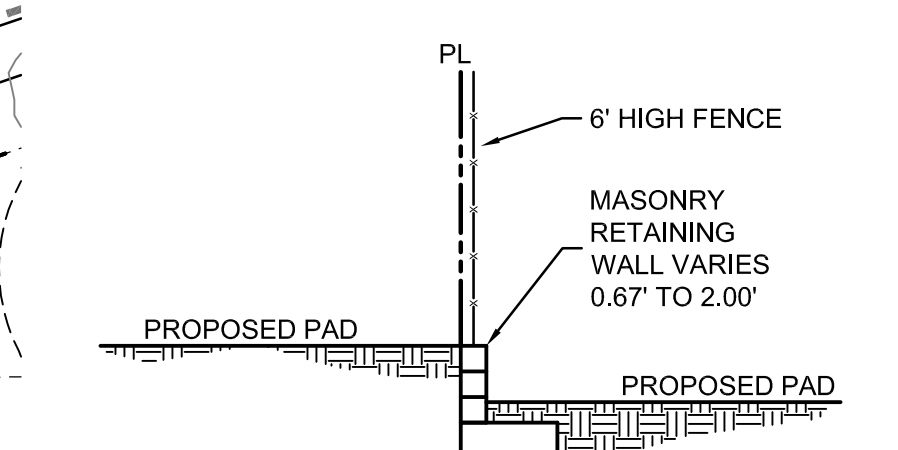

SECTION B-B
 NO SCALE

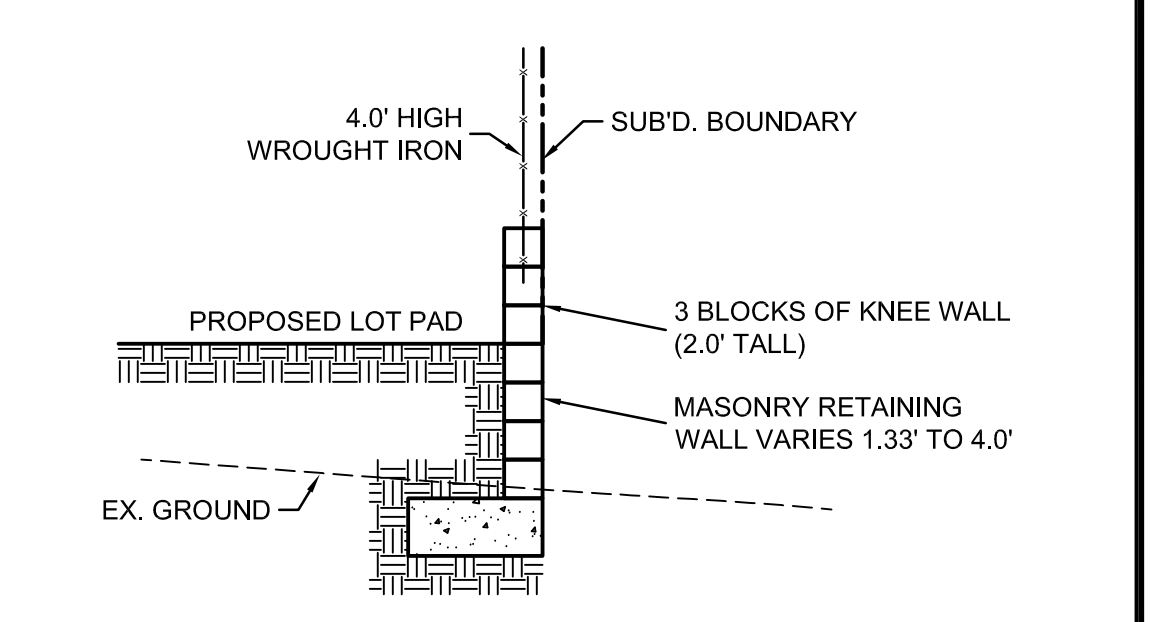

SECTION D-D
 NO SCALE

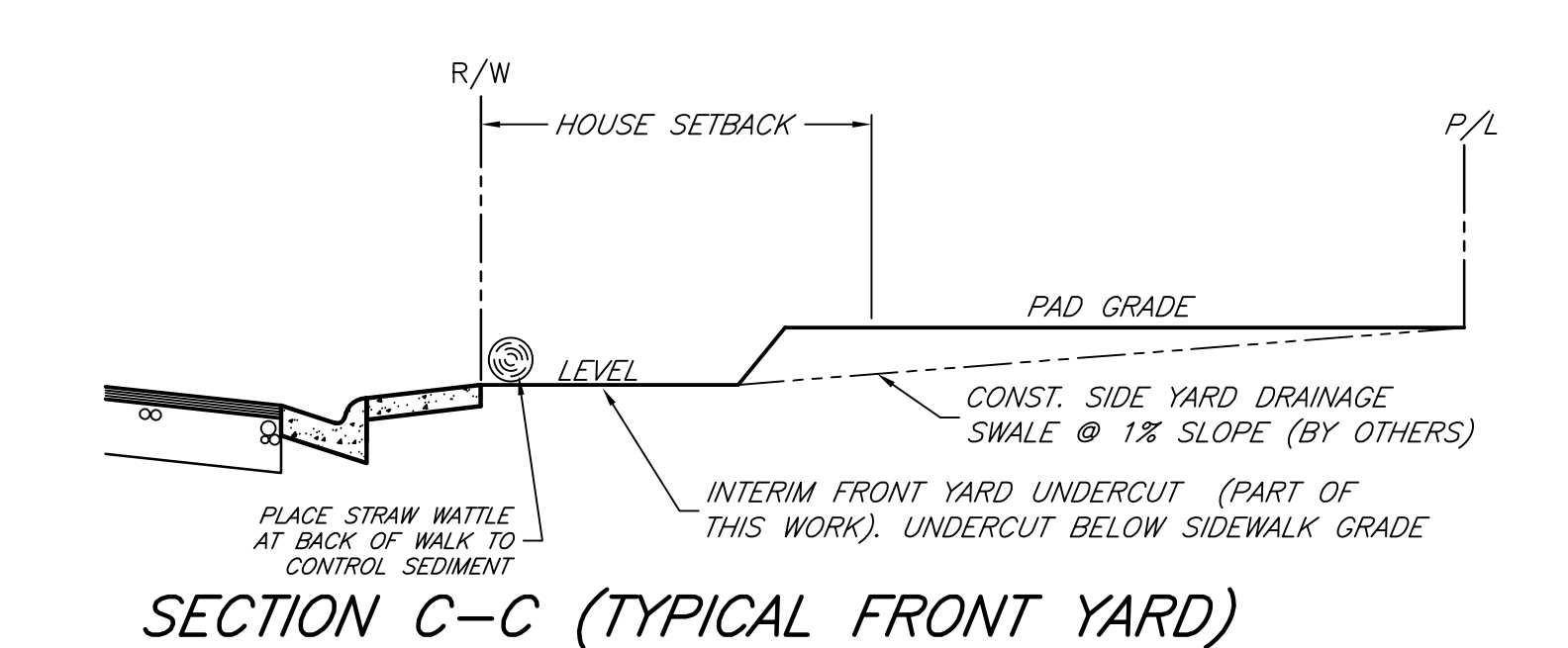

SECTION C-C (TYPICAL FRONT YARD)
 NO SCALE

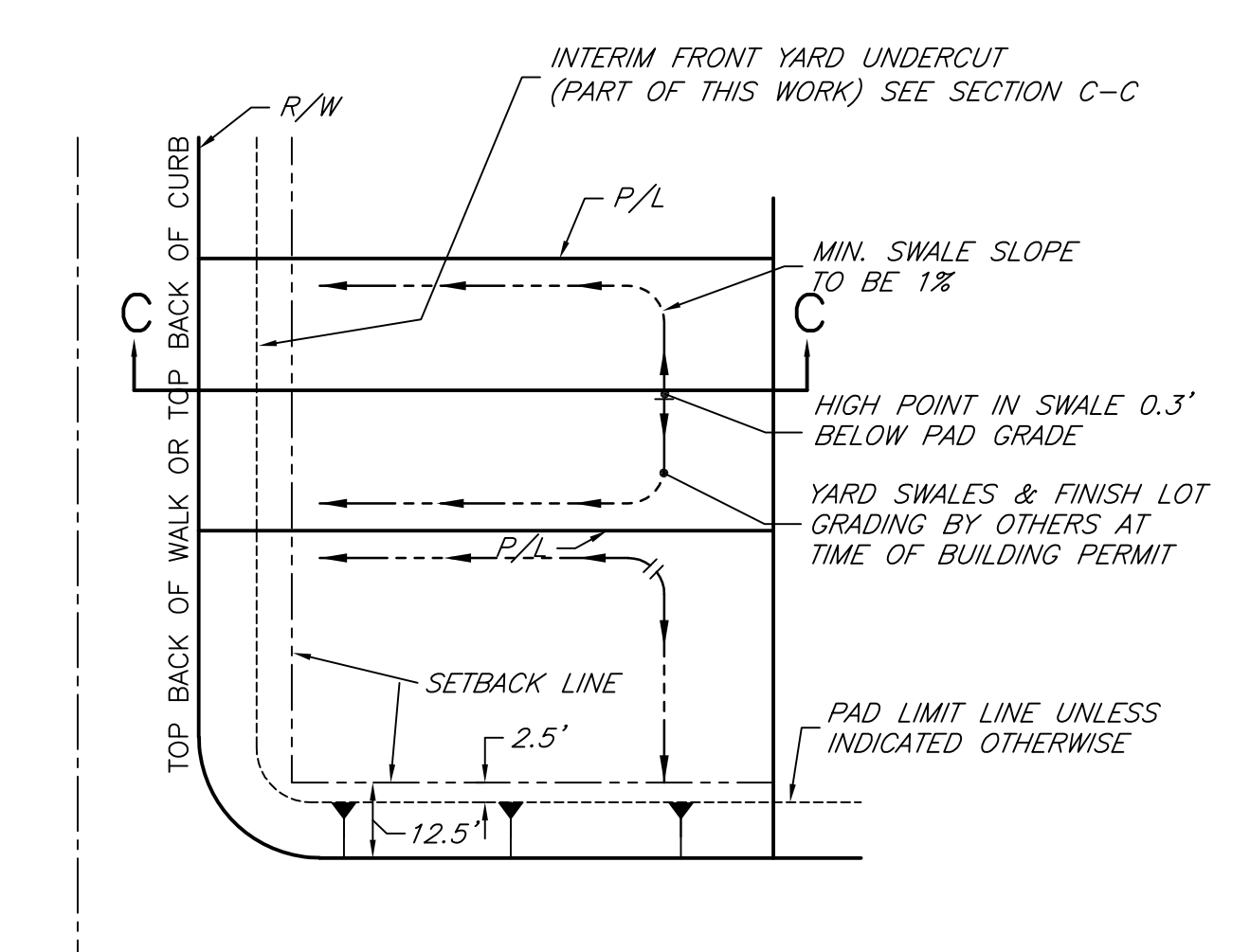

TYPICAL LOT GRADING
 NO SCALE

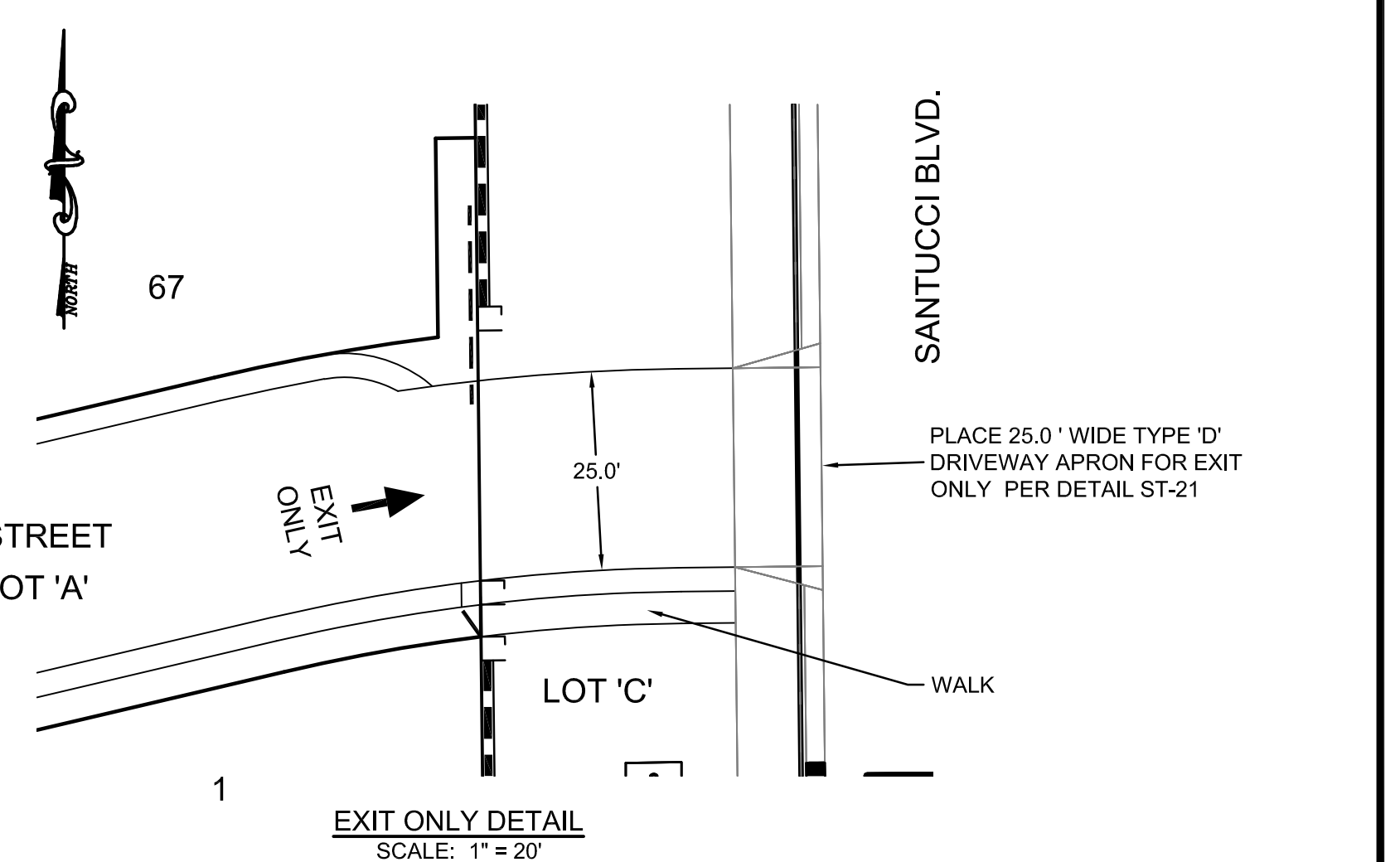

EXIT ONLY DETAIL
 SCALE: 1"=20'



SEE SHEET 2 FOR STRIPING ON VISTA GRANDE BOULEVARD ALONG CO-3 FRONTAGE